



# Loop Interface Manual



**PP5099 Revision 1**  
**Hub Firmware 1.0.4**

## Table of Contents

<b>REACH User Manual Introduction</b>	<b>3</b>
<i>Technical Specification</i>	3
<i>Warnings and limitations</i>	3
<b>Suitability</b>	<b>4</b>
<i>Building Considerations</i>	4
<i>Wireless Considerations</i>	4
<i>Wiring Considerations</i>	4
<i>Apollo Protocol Support &amp; Panel Compatibility</i>	4
<b>Surveying</b>	<b>5</b>
<b>Installing the REACH Loop Interface</b>	<b>6</b>
<b>User Interface</b>	<b>8</b>
<b>PCBA Diagram</b>	<b>8</b>
<b>Display Symbols &amp; Status LEDs</b>	<b>9</b>
<b>Commissioning - First Time Setup</b>	<b>10</b>
<i>Time &amp; Date</i>	10
<i>RF Channel Selection</i>	10
<i>System ID</i>	11
<i>Hub Loop Address</i>	11
<b>Device Menu</b>	<b>12</b>
<i>Add Device - Pairing Products to the Loop Interface</i>	12
<i>Add Device - Pairing an already paired device</i>	14
<i>Add Device - Manual Addressing</i>	15
<i>Modify Device</i>	16
<i>Loop Address</i>	17
<i>Device-Specific Settings</i>	18
<i>About</i>	18
<i>Replace Device</i>	19
<i>Remove Device</i>	20
<b>Hub Settings</b>	<b>21</b>
<i>Critical Settings</i>	22
<i>Password</i>	22
<i>External Jamming</i>	22
<i>Tamper</i>	22
<i>About</i>	23
<i>Tone Period (S)</i>	24
<b>System Status</b>	<b>25</b>
<i>Device Event Log</i>	25
<i>View Device Status</i>	25
<i>Device Link Quality</i>	26
<i>Background Noise</i>	27
<b>Config. Mode</b>	<b>27</b>
<b>Appendix 1: REACH / XPander RF Channel Map</b>	<b>28</b>
<b>Appendix 2: Device XP95 Device Codes</b>	<b>28</b>
<b>Appendix 3: Device Analogue Values</b>	<b>29</b>
<b>Appendix 4: Event Log Messages</b>	<b>30</b>

# REACH Wireless®

## User Manual

### Introduction

REACH Wireless is Apollo's range of hybrid-wireless fire alarm products. It offers a range of wireless alternatives to many fire safety products and is designed to solve challenging installation scenarios for structures with restricted or complex access and installation conditions such as listed buildings, out-buildings & temporary structures where wired installation or long site downtime is not possible.

REACH provides flexibility and ease in system design and provides the confidence of a well-known name in fire safety solutions.

The purpose of this manual is to provide detailed instruction for the installation and commissioning of a REACH Wireless system, beyond the basic fit and wiring of the Quick Start Guides that are included with the product and are available at [apollo-fire.co.uk](http://apollo-fire.co.uk).

### Technical Specification

Specification	Value
Power Supply Voltage Range (from intelligent loop)	from 17 Vdc to 48 Vdc (35 Vdc + 13 V pulses)
Typical Current Load	40 mA (regardless of the power supply voltage)
Wireless Frequency Band	868 MHz
Radiated Power Value	14 dBm (25 mW)
Number of Wireless Channels	66
Wireless Communication Range**	200 m in open space
Maximum Number of Linked Child Devices	32

Short-Circuit Protection Specification	Acronym	Min.	Typical	Max.	Unit	Notes
Line Voltage	-	17	24	48	V	35 Vdc + 13 V pulses
Maximum Rated Continuous Current with the Switch Closed	$I_{c\ max}^*$	-	-	1	A	
Maximum Rater Switching Current	$I_{s\ max}^*$	-	-	3	A	
Leakage Current with the Switch Open	$I_L^*$	-	-	33	mA	
Series Impedance with the Switch Closed	$Z_c$	-	-	0.10	$\Omega$	
Voltage at which the Device Isolates	$V_{so}$	12.5	-	15	V	
Voltage at which the Device Reconnects	$V_{co}$	12.8	-	19.1	V	

### Warnings and Limitations

Our devices use high quality electronic components and plastic materials that are highly resistant to environmental deterioration. However, after 10 years of continuous operation, it is advisable to replace the devices in order to minimize the risk of reduced performance caused by external factors.

Ensure that this device is only used with compatible control panels.

Detection systems must be checked, serviced and maintained on a regular basis to confirm correct operation.

Smoke sensors may respond differently to various kinds of smoke particles, thus application advice should be sought for special risks.

Sensors cannot respond correctly if barriers exist between them and the fire location and may be affected by special environmental conditions.

Refer to and follow national codes of practice and other internationally recognized fire engineering standards.

Appropriate risk assessment should be carried out initially to determine correct design criteria and updated periodically.

Use only in REACH Wireless fire detection and alarm systems.

## Suitability

### Building Considerations

The following should be considered when considering REACH Wireless for a building. Each of the below items will negatively impact signal strength or consistency. This does not necessarily prevent REACH from being a viable solution, but should be considered during the up-front site survey to help plan the system layout:

- Thick, solid walls e.g. historic buildings
- Large amounts of metal in the structure such as steel girders, metal wire mesh, HVAC systems etc.
- Cabling – especially heavy gauge or high current

### Wireless Considerations

Be aware of other wireless equipment in the installation area that operates within the same 868Mhz band. If possible, avoid using the same 868Mhz channels as these devices to avoid communication issues.

If installing near an Apollo XPander system, please also be aware that RF channel frequencies are not aligned across these systems, so selecting different channel numbers may still result in clashes. Please refer to the RF channel loop-up sheet (appendix 1) to compare.

A 2m minimum distance must be kept between all REACH Wireless products to prevent signal loss.

### Wiring Considerations

Apply mandatory codes of practice and standards of your country.

- Don't install wireless devices in the vicinity of large electrical equipment, fluorescent light fixtures, computers or their power and network cabling.
- Don't install wireless devices in the vicinity of large metal objects, structures or metal ceiling structures.
- Do ensure that all REACH products adhere to a minimum installation distance of 2 meters between each other.
- Do install the RW1700-030APO Loop Interface at a height of at least 2 - 2.5 meters from the floor, fixed flat on the wall.

### Apollo Protocol Support & Panel Compatibility

REACH Wireless is a hybrid wireless solution, meaning it must be connected to a wired loop to function and cannot operate as a standalone solution.

The RW1700-030APO loop interface acts as the wireless panel for the Reach Wireless products. It is the primary device in the system and acts as the parent or host of the wireless network. The RW1700-030APO loop-interface must be connected to the wired addressable loop in order to communicate with the wired loop's control panel and in order to power on. It will act as the bridge between the wired and wireless network, translating communications between the wired panel and wireless devices and vice versa.

REACH communicates using the Apollo XP95 protocol natively, meaning it is compatible with Discovery and CoreProtocol loops as a legacy device. Its XP95 communication is designed to mimic Apollo's legacy wireless solution, XPander, for maximum compatibility with panels. Fire panel features and technical specifications vary, so please refer to the panel's compatibility list to check for REACH Wireless support.

## Surveying

As REACH is a wireless solution, it is imperative that potential installations sites are surveyed for suitability ahead of system installation. This protects against additional installation costs or failure due to unforeseen issues with the environment or building structure.

REACH Wireless products interface with an Apollo XP95 wired loop, via the RW1700-030APO Loop Interface, so it is important to identify up-front potential locations to either break into an existing wired loop or where to run a new loop to.

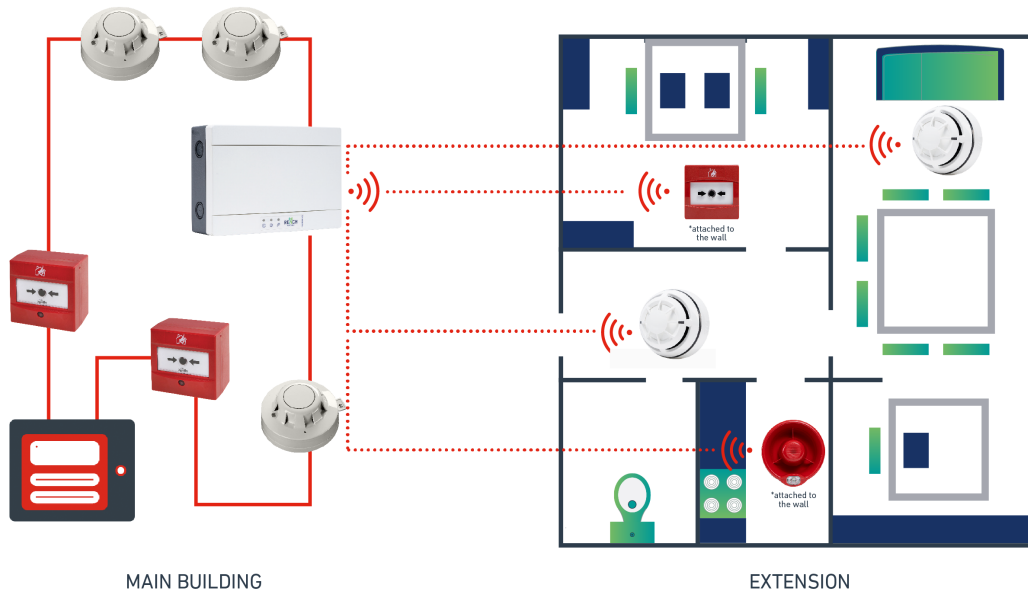

Ideal locations for the RW1700-030APO Loop Interface should be as central as possible to where the other REACH Wireless devices will be located, in order to maximize the circumference of available wireless range. This is not always possible, for example in a building extension, where the existing wired loop will only run to the boundary of where the products will be installed (such as in the graphic below).

Performing a survey requires use of RW1800-060APO Reach Survey Kit. This survey kit contains a battery-powered hub and mock detector, that can be used to test the signal strength of each product install location, for each potential install location of the RW1700-030APO Loop Interface.

**Instructions of how to perform the survey are available in the Survey Kit's manual PP5098.**

*While surveying, consider that a 2m minimum distance must be kept between all REACH Wireless devices to prevent signal loss.*

The results of the survey should be recorded in the official REACH Survey Sheet available from [apollo-fire.co.uk](http://apollo-fire.co.uk). This is critical as it will inform key decisions such as RF Channel when it comes to installation and will be requested by Apollo if support is required during or after installation.

## Installation

Prior to installation, a site survey must have been completed and the official REACH Survey Sheet (available from [apollo-fire.co.uk](http://apollo-fire.co.uk)) must be available. Installing the REACH Loop Interface: **Included equipment 1 x Loop Interface Module 4 x Screws (wall plugs not provided)**

The Translator Module is IP65 rated, suitable for external mounting. The back box must be installed on the wall as flat as possible to retain IP rating, to prevent distortion of the housing and the ingress of contamination and/or moisture.

Start by removing the top and bottom front plastic covers that cover the white plastic screws.

Using a flat-headed screwdriver, unscrew all four screws and remove the lid from the back box.

*Be careful to use an appropriate-sized screwdriver head, as failure to do so may deform the screw head.*

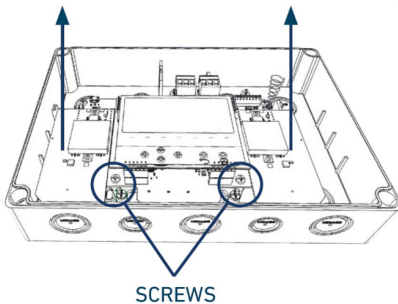
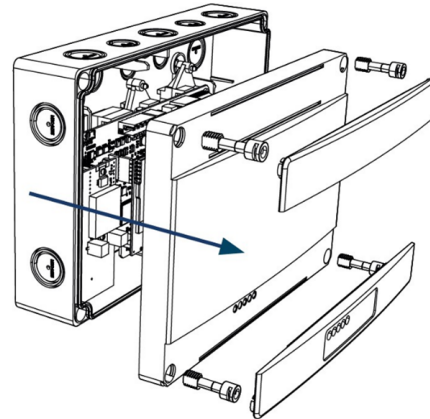

Using a suitable-sized drill bit (4mm), drill the pre-defined mounting points in the four corners of the back-box.

*While it is possible to mount the product using the inner four mounting points which provide pivot adjustment, these will prevent the product from retaining its IP65 protection.*

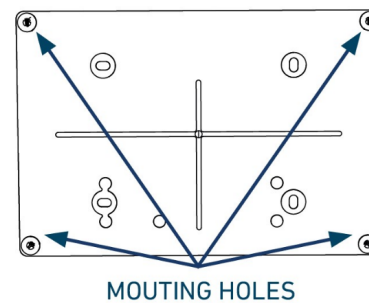

Remove the electronic PCB assembly from the back-box by un-screwing the two Philips screws below the display, then sliding the PCB up and out.

*This is to prevent damage to the PCB while drilling through the mounting and wiring knock-outs.*

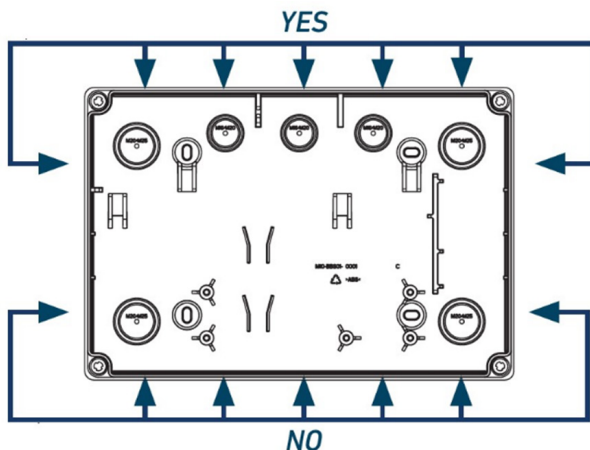

Determine which of the 20mm knock-outs would best suit your wiring in to the addressable loop.

Ensure that only the top knock-outs are used, not the bottom ones as the loop terminals are located at the top of the PCB and the radios are at the bottom. Passing the loop cables near the radios may reduce signal strength.

Once selected, drill through while considering the cable gland that you are going to use.

*In order to maintain the IP rating of the product, use IP67 cable glands.*

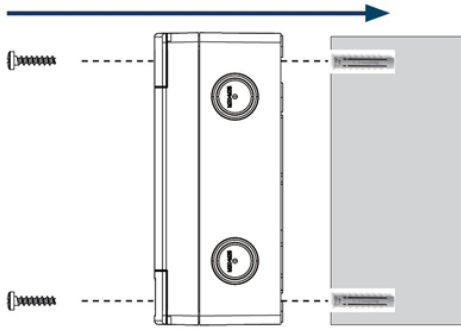

Fix the back-box to the wall using wall plugs and round-headed Phillips screws in all of the fixing holes.

*Note: Screws and wall plugs are not provided.*

Ensure that multiple **RW1700-030APO** Loop Interface units are installed with a minimum distance of at least 2 meters between them.

Install with a minimum height from the floor of 2-2.5 meters.

Re-insert the PCB into the mounted back-box using the two Phillips screws.

Bring the addressable loop wires in through the cable gland and wire into the loop-in/loop-out terminals as-per the wiring diagram.

Ensure that the loop is powered-off before wiring in the product.

*Note: The **RW1700-030APO** Loop Interface includes a built-in bi-directional isolator (based on an Apollo 20C isolator). This automatically opens when the loop voltage falls below a fixed threshold to prevent a loop crash or abnormal current consumption.*

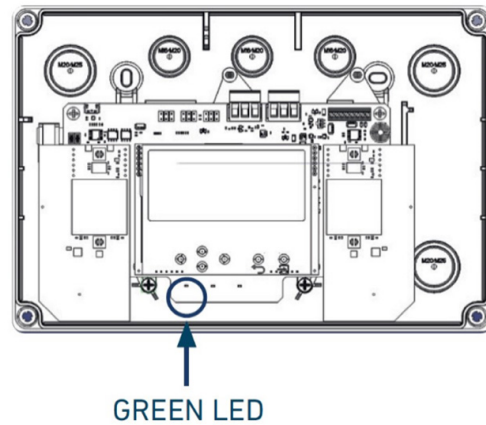

GREEN LED

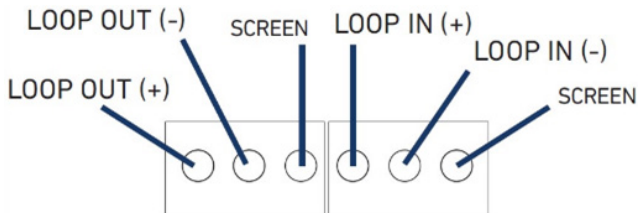

When wired into the loop and after ensuring that cables are in the correct terminals, power the loop back on.

The **RW1700-030APO** Loop Interface should power up, showing a flashing green LED and the REACH Wireless logo on the LCD screen. If this does not happen, re-check the installation steps.

After the **RW1700-030APO** Loop Interface starts-up, it will present the First-Time-Setup wizard. See the Commissioning instructions to continue with the system setup. After finishing commissioning, re-install the **RW1700-030APO** Loop Interface lid by re-installing the four plastic screws and push-clicking the top and bottom plastic covers back in place.

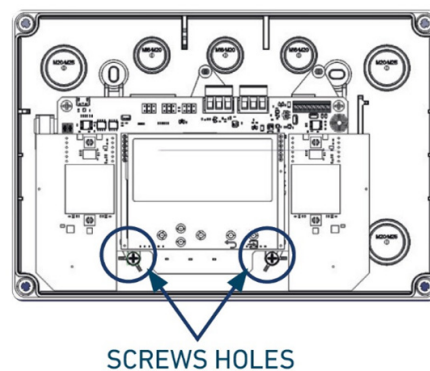

SCREWS HOLES



## User Interface

The **RW1700-030APO** Loop Interface's embedded user interface is used to configure the REACH installation.

The user-interface consists of:

- **Arrow Keys: Up/Down/Left/Right**
- **Back**
- **Enter**

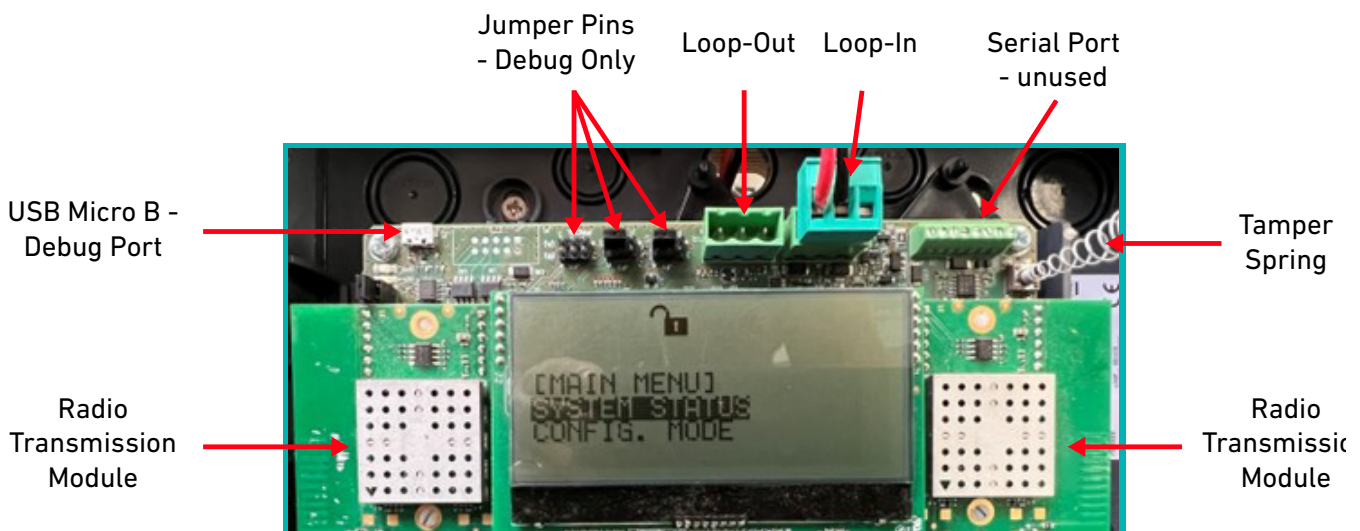







- **USB Micro B Debug Port:** Used for internal debugging only
- **Jumper Pins:** Used for internal debugging only. Do not move or re-move these jumpers as it may cause the Loop Interface to become partially or fully unresponsive. These should remain as shown above
- **Loop-Out / Loop-In port:** See Installation section for wiring diagram
- **Serial Port:** Reserved for future use
- **Radio Transmission Modules:** Used to communicate with REACH Wireless Devices



## Display Symbols & Status LEDs

The **RW1700-030APO** Loop Interface's LCD screen features status symbols to provide feedback.

Fault Type	Description	Display Symbol	Status LED
-	The loop interface (Hub) is energized and in normal operation.	-	Steady Green
-	The loop interface is in configuration mode. In this mode, the loop interface does not communicate with the fire alarm control panel.	-	Steady Blue
-	The loop interface is looking for its paired wireless devices. This normally happens when the loop interface has been de-energized / re-booted. To see the current status of paired devices, use the system status menu.	-	Flashing Blue
Battery Fault	The battery of one or more devices is low/empty.		-
Link Fault	No connection from one or more devices in.		Fault LED Blinking
Tamper Fault	One or more devices give a tamper message.		Hub- Fault LED Blinking Device - Fault LED Steady
General Fault	A general fault is present in the system, loop interface or element.		Hub- Fault LED Blinking Device - Fault LED Steady
Fire Alarm	There is an active fire alarm on one or more elements.		-
USB Connection	There is communication with the computer (via the USB debug port).		-
RF Communication Jamming	Noise on RF communication channels in-use.		Yellow Fault LED Blinking
Start-Up	Displays during device power-up. Normal operation.		Yellow Fault LED Blinking 1s ON / 2s OFF
Isolator	Isolators active.		Yellow Fault LED Steady ON
Bridge Fault	Communication error between internal microprocessors (hardware error).		LCD Message: 'Interface Fault'

## Commissioning

### First Time Setup

*Note: the commissioning steps assume that this is the first power-on and therefore the first-time-setup wizard will be shown. These settings are critical for a system setup. If first-time-setup does not show, all of the same settings are available in the 'Hub Settings' menu and should be set according to the following instructions.*

*Note: The RW1700-030APO Loop Interface features a tamper protection spring-loaded button that will be triggered while the front cover is not installed. This will show on the LCD display as a tamper fault during setup, as well as analogue value of '4' on the fire panel once the system is released, until the front-cover is re-installed.*

Before getting started, please ensure that:

- RW1700-030APO Loop Interface is physically installed, connected to the wired addressable loop and powered-on.
- The official Apollo REACH Survey Sheet (available from Apollo-Fire.co.uk) that was used for the survey is available, with the RF channel pair and product install locations listed.
- All products intended to be installed are available.

### Time & Date

The date and time is used for local log events. It is important to set accurately to aid with troubleshooting if required.

It is set in the following format:

Day / Month / Year --- Hour : Minutes

**Use the arrow keys to change values**  
**Press 'Enter' to confirm and proceed.**

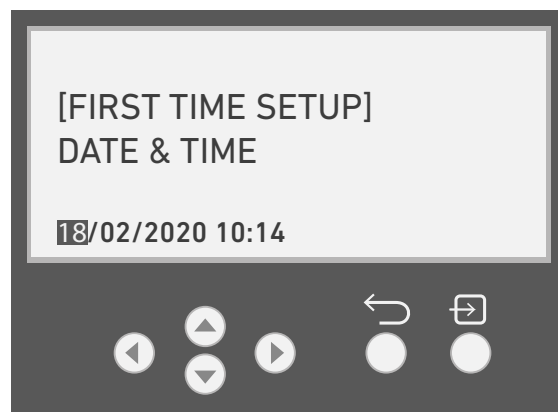

### RF Channel Selection

*This information should be already determined in the Survey Sheet that, from the survey carried out ahead of the system installation. If this is not available or a survey has not taken place, follow the surveying steps.*

REACH offers 22 RF channel pair options. Each pair consists of a primary and secondary communication channel, in accordance with EN54-25, with 1Mhz separation between them.

If you are installing multiple Hubs in the same area, select the different RF channel pairs for each Loop-Interface to avoid communication interruptions.

RF channels should be assigned in the order that they appeared in the background channel scan, as per of the survey, which should be already recorded and available in the survey sheet.

**Use the arrow keys to change values**  
**Press 'Enter' to confirm and proceed.**

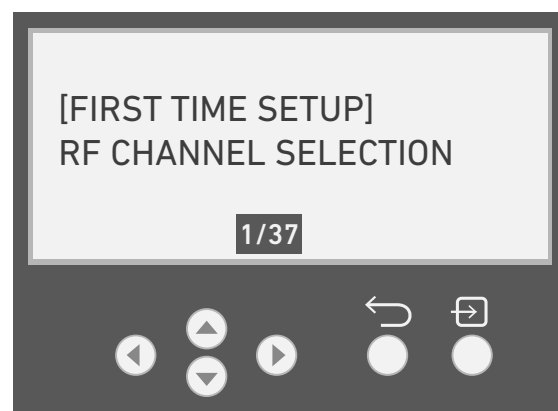

The system ID number a number is used to identify communications between the Loop-Interface and the device they are paired with when present in the same area and operating on the same RF channels. This **will not** prevent communication interruptions but will mitigate communication errors and corruption.

Best practice is to use a unique System ID value for every Hub device in the area.

System ID is a value between 1 and 254 and is randomized by default (for the above reasons).

**Use the arrow keys to change values.**

*Note: Every digit can be scrolled individually to speed up selection.*

**Press 'Enter' to confirm and proceed.**

Record the selected value in the REACH Commissioning Sheet (available from [apollo-fire.co.uk](http://apollo-fire.co.uk)).

*If installing multiple Loop-Interfaces in the same site, ensure this value is different for each, even when using different RF Channel pairs for each Loop-Interface as well.*

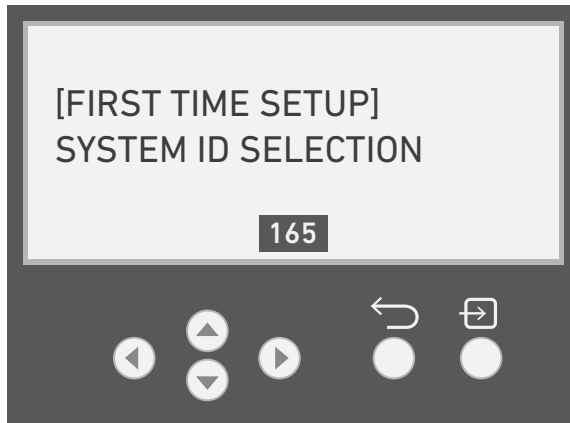

**Hub Loop Address**

This is the address that the **RW1700-030APO** Loop Interface will use on the wired addressable loop.

As **RW1700-030APO** Loop Interface is an XP95 device, valid addresses are between 1 and 126.

**Use the arrow keys to change values.**

**Press 'Enter' to confirm and proceed.**

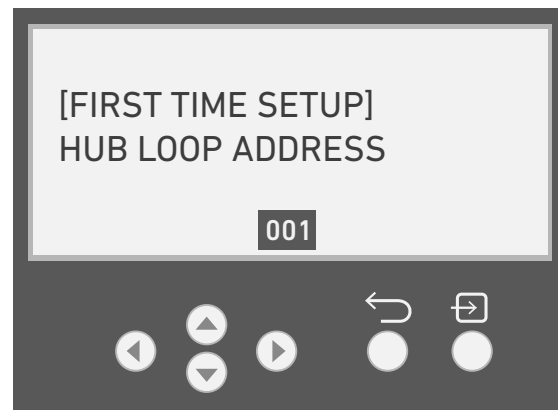

*Note: Although the **RW1700-030APO** Loop Interface is wired-in to the loop and powered-on, it will not announce itself to the panel at the address set until setup is complete and the system is released. Each time the Loop-Interface is in configuration mode, it and all associated wireless devices will stop responding to the panel until configuration mode is exited again.*

*Note: The recommended Hub address would be the beginning of a large, free address block on the addressable loop. This is because when pairing REACH devices to the Loop-Interface, the first product will be auto-assigned as [Hub Address +1], then [Last Assigned Address +1]. These addresses can be changed manually before the system is released.*

This is the final step in the first-time setup process. After proceeding from this screen, the Configuration Mode menu will be presented.

From here, REACH Wireless devices can be paired with the **RW1700-030APO** Loop Interface to continue the commissioning stage. When complete, the 'Exit' option can be used to save the setup configuration and release the system and then the Loop-Interface front-cover can be re-installed. **This is a critical step to make the system functional.**

Additional **RW1700-030APO** Loop Interface settings will also be available from this menu, however, most of them are only required to assist in problem-solving. Most installations will avoid the need to utilize these if they have been properly surveyed and the installation instructions have been followed correctly. In the event that problems do occur, the Apollo technical support team are available to assist and may recommend changing some of these settings.

## Device Menu

### Add Device - Pairing Products to the Loop-Interface

*Note: In order to pair products to your REACH system, the **RW1700-030APO** Loop Interface must be in Configuration Mode. If you have just completed the first-time setup process, you will be navigated to the Configuration Mode menu automatically. If the system has been released, select 'Configuration Mode' on the Main Menu and enter the password.*

*Note: The default password is 0002, but this can be changed in the 'Hub Settings' menu.*

To begin pairing products to the **RW1700-030APO** Loop Interface:

From the [CONFIG. MODE MENU] navigate to **DEVICE MENU**.

In the [DEVICE MENU], select **ADD DEVICE**.

The [ADD DEVICE PROCESS] screen will appear.

While this screen is displayed, the **RW1700-030APO** Loop Interface is scanning for REACH products that have been placed into pairing mode.

Each REACH product contains a pairing switch. Locate this switch by referring to that individual product's quick-start guide. It is typically located in the battery compartment.

By default, this switch should be in the 'ON' position. Ensure that it is in this position before batteries are inserted.

Insert the batteries by lining up the polarity +/- symbols of the CR123 batteries included with the product, with the +/- symbols on the product. Lower both batteries on one side, then push down on the other side in parallel. **The device LEDs should flash three times to confirm power-up.**

*Note: The battery polarity (+/-) symbols may be on the battery terminals, printed on the PCBA, applied with a label or be part of the plastic molding.*

*Note: Both batteries **must** be inserted at the exact same time to avoid the product waking and reporting a missing or dead battery. This will show as a fault on the **RW1700-030APO** Loop Interface LCD display and will take up-to several minutes to clear.*

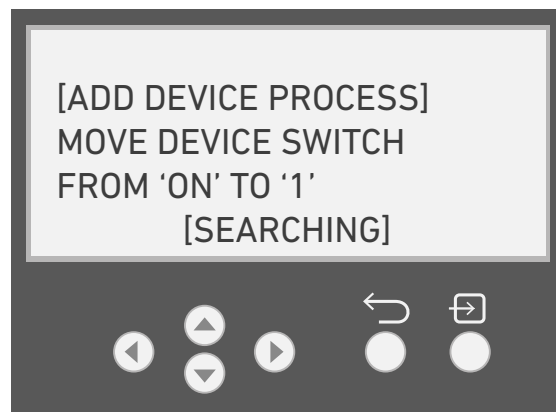
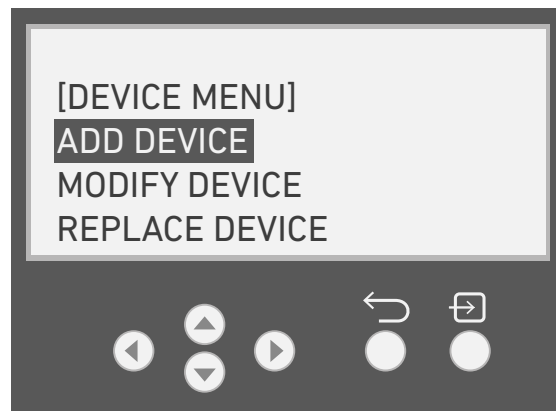
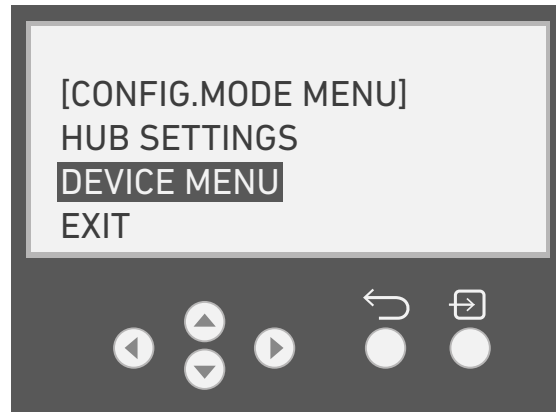

With both batteries inserted into the product correctly, move the pairing switch from the 'ON' position to the '1' position.

*Note: Ensure that the device had time to power-up after battery insertion (LED should flash three times). **If the pairing switch is moved too soon, the device won't be found.** In this case, set the switch back to 'ON', remove then re-insert the batteries and move the pairing switch again.*



Once the switch is moved, the **RW1700-030APO** Loop Interface LCD should display 'DEVICE FOUND'.

*Note: At this step, the **RW1700-030APO** Loop Interface is writing critical settings to the device via the pairing RF channel, then waiting for the device to reboot and communicate back on the RF Channel Pair configured during setup and with the correct System ID code.*

Once the **RW1700-030APO** Loop Interface receives a response from device being paired, it will read the attributes of that device and confirm on the LCD what type of product it is.

At this stage, the **RW1700-030APO** Loop Interface will also automatically assign a loop address to that product.

The [ADD DEVICE PROCESS] will pause at this point to allow you to record the loop address of the product.

**To pair another product, select **NEXT**.**

**To finish pairing products, select **EXIT**.**

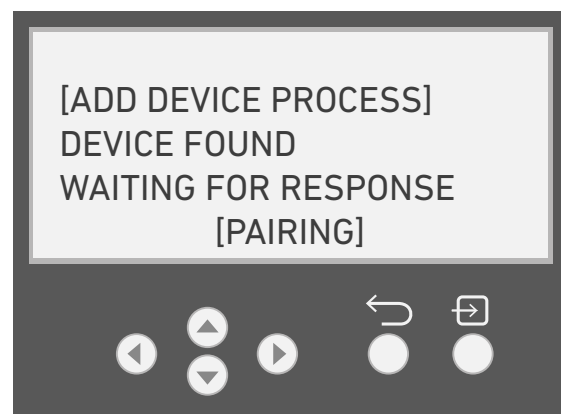

*Note: The first product will be auto-assigned as [Hub Address +1], then [Last Assigned Address +1] for each subsequent product paired. These addresses can be changed manually before the system is released.*

*Note: Although the RW1700-030APO Loop Interface is wired-in to the loop and powered-on, it will not announce itself or paired devices to the panel at the addresses set until setup is complete and the system is released. Each time the Loop-Interface is in configuration mode, it and all associated wireless devices will stop responding to the panel until configuration mode is exited again.*

*Note: REACH Heat Detector will ask which operating mode should be set, 'ROR' rate-of-rise or 'HT' static. Refer to the product datasheet for details.*

*Note: REACH Open-Area AV products will ask whether a 'beacon' is present, as well as a sounder. This does not change product operation but will prevent it from being correctly labelled in the Hub menu.*

### Add Device - Pairing an already paired device

If the device currently being paired has already been paired with the system, the **RW1700-030APO** Loop Interface will display the following message:

*The already assigned loop address for the product being paired is indicated by 'old', and the newly auto-assigned address is shown as 'new'*

Once you've reviewed this information, press **ENTER**. The **RW1700-030APO** Loop Interface will ask how to handle this situation, as one product cannot be paired twice.



The next screen will ask if the existing product settings should be retained for the already paired device. The default option is **YES**, as this is non-destructive if you have re-paired by mistake.

*Note: when selecting **NO**, the **RW1700-030APO** Loop Interface will attempt to overwrite settings on the product before proceeding*

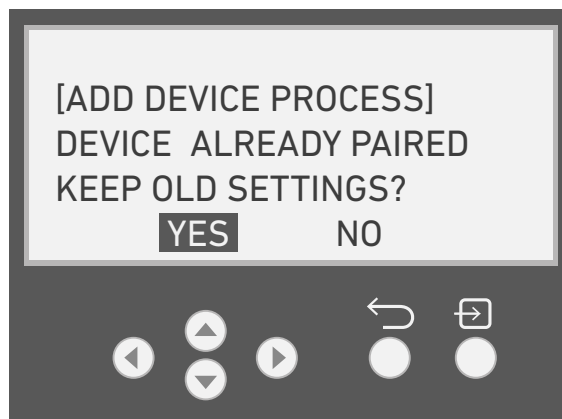

The next screen will ask if the loop address should be retained for the already paired device. The default option is **YES**, as this is non-destructive if you have re-paired by mistake.

*Note: when selecting **NO**, the **RW1700-030APO** Loop Interface will use the newly generated auto-address. When selecting **YES**, the **RW1700-030APO** Loop Interface will use the loop address that the device had previously been assigned.*



After making these decisions, the **RW1700-030APO** Loop Interface will show the same add device summary screen as normal.



### Add Device - Manual Addressing

By default, devices paired to the **RW1700-030APO** Loop Interface will be automatically assigned a loop address. It is possible to manually change this address at the point of pairing, without leaving the Add Device process.

*Note: The first product will be auto-assigned as [Hub Address +1], then [Last Assigned Address +1] for each subsequent product paired. These addresses can be changed manually before the system is released.*

At the Add Device summary screen, press the **UP** button to highlight the address.

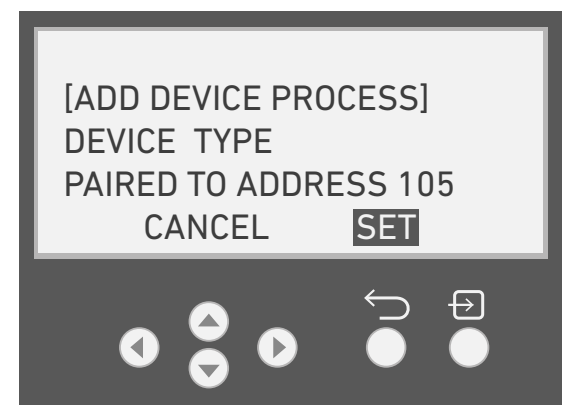
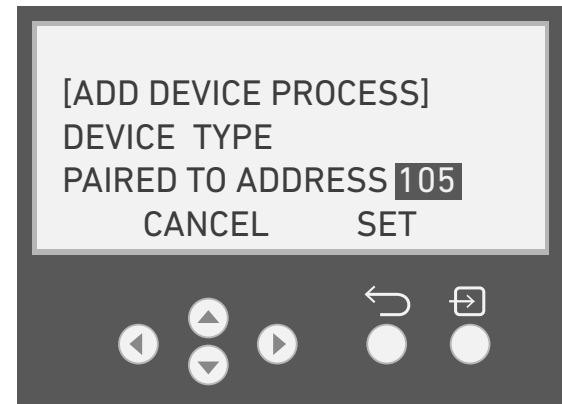

With the address highlighted, use the LEFT and RIGHT arrows to change address. Addresses already in-use by other devices paired to the **RW1700-030APO** Loop Interface will be selectable.

When the address value is changed, the **NEXT** option on the bottom row will change to **SET**.

To save the new address, press the **DOWN** button to highlight **SET**, then press **ENTER**.

To cancel the change, press the **DOWN** button to highlight **SET**, then press the **LEFT** button to highlight **CANCEL**, then press **ENTER**.



The LCD will then display the regular Add Device summary screen options.



### Modify Device

It is possible to change the settings of REACH Wireless devices that have been paired to the **RW1700-030APO** Loop Interface, via the LCD display. This cannot be done via the wired fire panel as REACH is an XP95 protocol device.

The [MODIFY DEVICE] function will allow you to view device loop address, device settings (if available) and the unique device ID (shown on the device's label).

To modify the settings of a REACH device, on the **RW1700-030APO** Loop Interface:

From the [CONFIG. MODE MENU] navigate to **DEVICE MENU**.

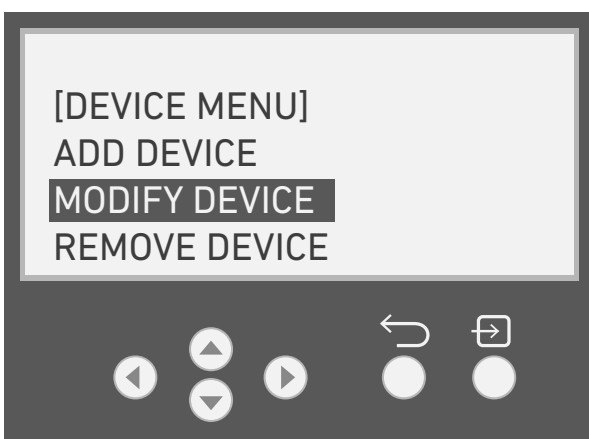
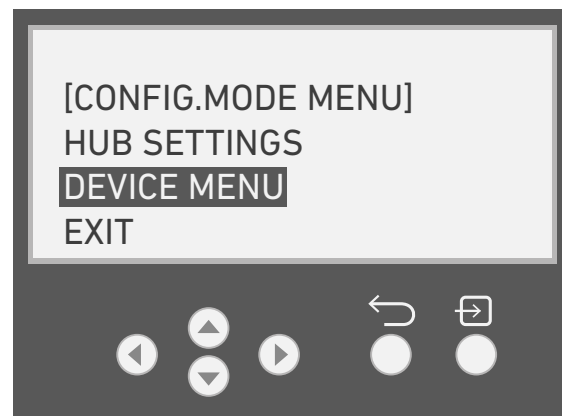

In the [DEVICE MENU], select **MODIFY DEVICE**.

Select the loop address of the device you wish to view/modify.

*Note: Once a device setting has been changed, you must select **SAVE & EXIT** before leaving the **[MODIFY DEVICE]** menu. This is located below the **ABOUT** menu option.*

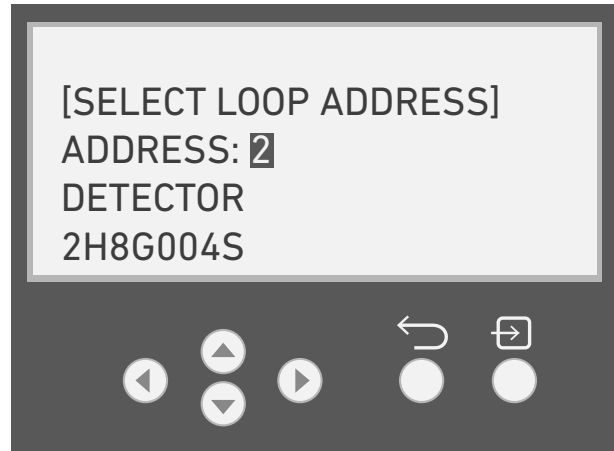

**Loop Address**

This screen is used to change the address of the device on the addressable loop.

This can be set to any value between 1 and 126.

Addresses assigned to other REACH devices paired to the loop-interface will be skipped in this list, as they are not available (unless changed first).

The Loop-Interface is not aware of other devices on the addressable loop, so please refer to the fire panel for a full list of available addresses.

**Use the up/down arrows to change the loop address.**

**Press 'Enter' to confirm.**

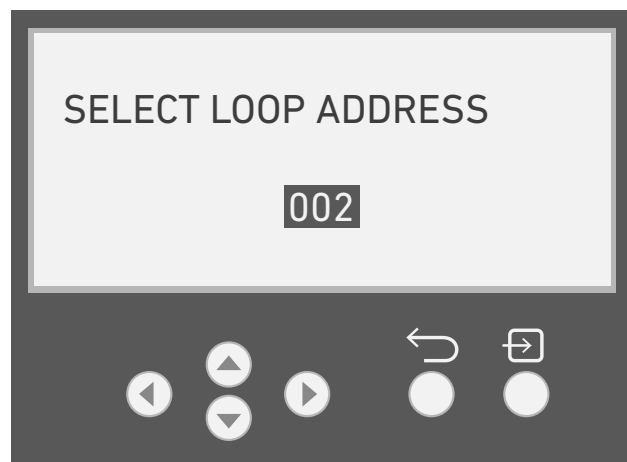
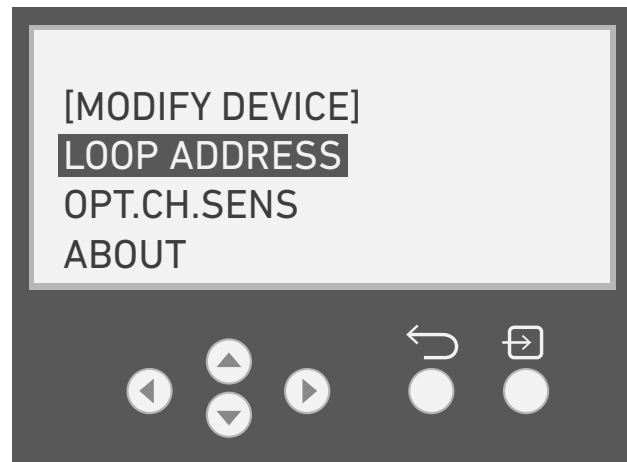

## Device-Specific Settings

This option will show in the [DEVICE MENU] as a different entry for certain device types.

An Optical Detector shows **OP.CH.SENS** which sets the detector's sensitivity mode.

Detector Sensitivity Modes that can be selected:

- High Sensitivity - suitable for clean environments
- Medium Sensitivity - Standard sensitivity, suitable for most standard applications
- Low Sensitivity - Low sensitivity, suitable for contaminated environments or where disturbances are expected such as shower fumes.

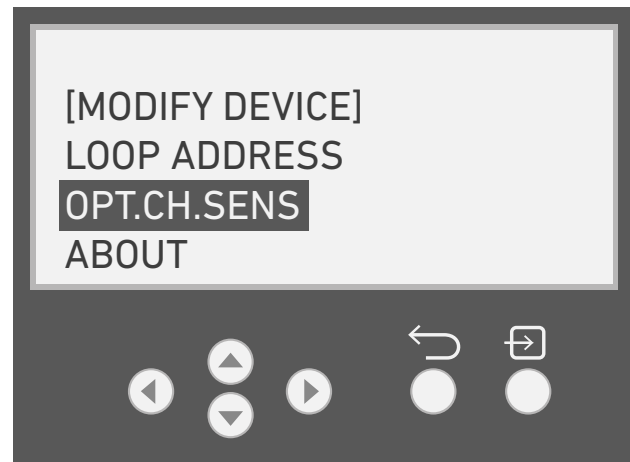

A Heat Detector shows SUBTYPE which sets the detector's operating mode, 'ROR' rate-of-rise or 'HT' static. Refer to the product datasheet for details.

An **Open-Area AV** product shows SUBTYPE which sets whether the device is a 'sounder' or is a 'sounder beacon'.  
An Heat Output Module shows:

- **OUTPUT CH. ENABLE** determines whether voltage (configurable) is applied to port A when the Output Module is sent a command to activate. It doesn't when disabled.
- **OUTPUT CH. SUPERVISED** which supervises the presence of a 10K EOL resistor connected to output port A, when enabled. It is not supervised when disabled.
- **OUTPUT CH. VOLTAGE** sets the voltage to be output on port A. This is configurable to 12V nominal or 24V nominal.
- **RELAY CH. ENABLE** determines whether the relay contact (port B) is activated when the Output Module is sent a command to activate. It doesn't when disabled.
- **RELAY SUPERVISED** which supervises the presence of a 10K EOL resistor connected to output port B, when enabled. It is not supervised when disabled.

## About

The about menu displays information about the device.

<b>Unique ID</b>	This is the unique identifier assigned to the device and can be found on the device menu. This can be used to locate the correct physical device if the loop-address has been changed from what was assigned on the commissioning sheet.
<b>Type</b>	The device type code (not aligned with Apollo Protocol type code). This tells you what kind of device it is. For example: - Detector - Sounder - Output Module
<b>Subtype</b>	More specific descriptor, additional to the (Type). E.g. - (Detector) Optical - (Sounder) VAD
<b>RF Address</b>	The wireless address number assigned to the device. Maximum of 32 per Loop-Interface.
<b>Firmware Version</b>	The firmware version of the device. Can be useful when calling Apollo technical support.
<b>Production Lot</b>	The month and year that the device was manufactured. If there is an issue with the device, Apollo may ask for this information.

## Replace Device

The replace device menu can be used to replace a REACH device that is faulty with another REACH device of the same type, whilst retaining the device settings.

*Note: Device settings that the **RW1700-030APO** Loop Interface can program on the device will be retained, however, some device settings can only be modified physically on the device. Ensure that these are matched when replacing devices e.g. Wall AV product DIP switches for tone and volume.*

To replace a device:

From the [CONFIG. MODE] menu, select **DEVICE MENU**.

In the [DEVICE MENU], select **REPLACE DEVICE**.

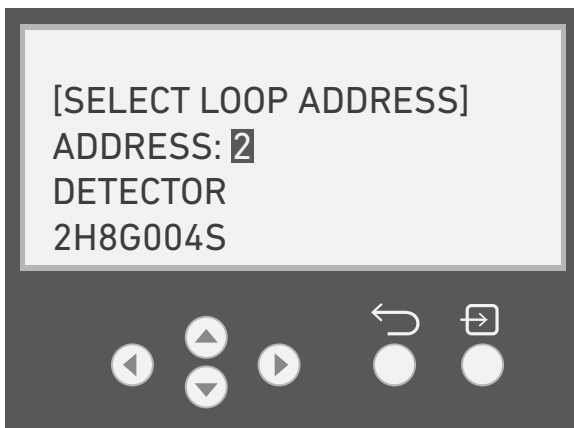
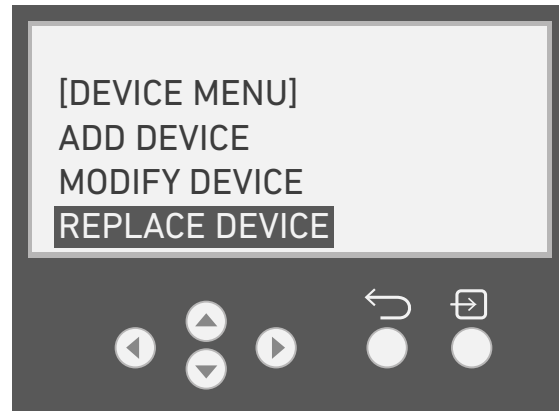

Select the device to be replaced by navigating through the assigned device loop addresses using the up and down arrows.

The device type and unique device ID for the device assigned to each address will be displayed. Match these identifiers to the physical device to be replaced.

*Note: The unique ID can be found on the product label.*

Select the product to be replaced by pressing the enter button.

The **RW1700-030APO** Loop Interface LCD will instruct you to remove the batteries of the device selected, then confirm.

*Note: By default, **ABORT** will be selected. This is to avoid accidental un-pairing. Use the arrow keys to select 'DONE' instead to proceed.*





The **RW1700-030APO** Loop Interface LCD will instruct you to set the **new** device into pairing mode. Follow the same steps as in the 'Add Device' section to successfully prepare the new device.

*Note: Once the device switch is moved on the new device, the **RW1700-030APO** Loop Interface LCD should find the device and will show multiple screens with the pairing progress. This is essentially the same as the 'Add Device' process.*

The **RW1700-030APO** Loop Interface LCD will inform you of whether the replacement was successful or not. If not, it will ask you to repeat steps.

### Remove Device

The remove device menu can be used to 'un-pair' devices from the **RW1700-030APO** Loop Interface.

To remove a device:

From the [CONFIG. MODE] menu, select **DEVICE MENU**.

In the [DEVICE MENU], select **REMOVE DEVICE**.

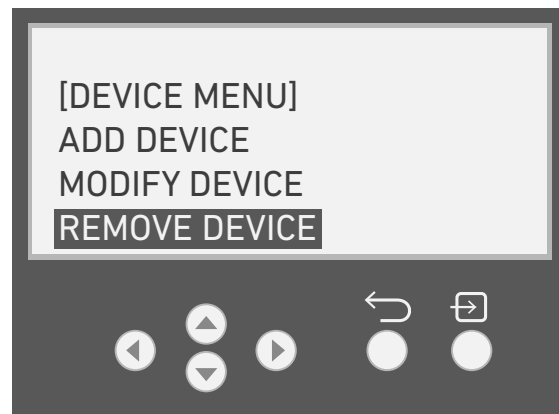

Select the device to be removed by navigating through the assigned device loop addresses using the up and down arrows.

The device type and unique device ID for the device assigned to each address will be displayed. Match these identifiers to the physical device to be removed.

*Note: The unique ID can be found on the product label.*

Select the product to be replaced by pressing the enter button.

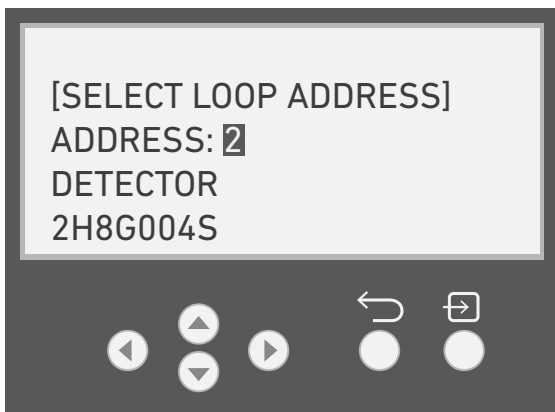

The **RW1700-030APO** Loop Interface LCD will instruct you to remove the batteries of the device selected, then confirm.

*Note: By default, **ABORT** will be selected. This is to avoid accidental un-pairing. Use the arrow keys to select 'DONE' instead to proceed.*





You will be asked to confirm that the device should be un-paired.

*Note: By default, **NO** will be selected. This is to avoid accidental un-pairing. Use the arrow keys to select 'YES' instead to proceed.*

The **RW1700-030APO** Loop Interface LCD will inform you that the device was removed. The loop address it occupied will be displayed here for your convenience.

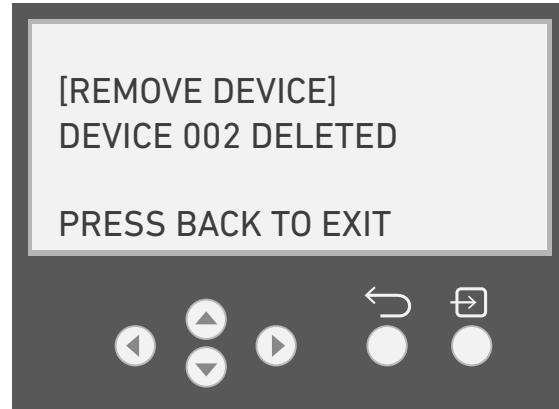

### Hub Settings

The Hub Settings menu is where REACH system settings are held, including critical settings that are set during the first-time-setup process. Most settings in this menu are only required to assist in problem-solving. Most installations will avoid the need to utilize these if they have been properly surveyed and the installation instructions have been followed correctly. In the event that problems do occur, the Apollo technical support team are available to assist and may recommend changing some of these settings.

*Note: Before leaving the Hub settings menu, any changes will only be saved if either:*

- **SAVE & EXIT** is selected at the bottom of the [HUB SETTINGS] menu
- When using the 'back' button to exit the menu, the Hub will ask whether you wish to **SAVE** or **EXIT**. **EXIT** is selected by default to prevent accidental changes.

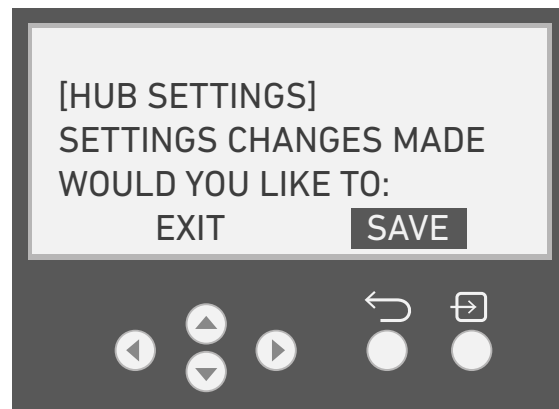

### Critical Settings

For instruction on these settings, view the First-Time-Setup section at the beginning of the manual.

Settings in this menu are not applied immediately, they are applied when leaving the menu.

Some of these settings are fundamental to the system operation and modifying them will initiate a factory reset whereby all settings on the **RW1700-030APO** Loop Interface will be dissolved and all paired devices will be un-paired.

### Password

This menu is used to change the password required to make changes to the **RW1700-030APO** Loop Interface settings. This password is used to enter Configuration Mode.

*Note: It is important to set this during initial system setup for increased security, otherwise the default password will be used. The default password is 0002.*

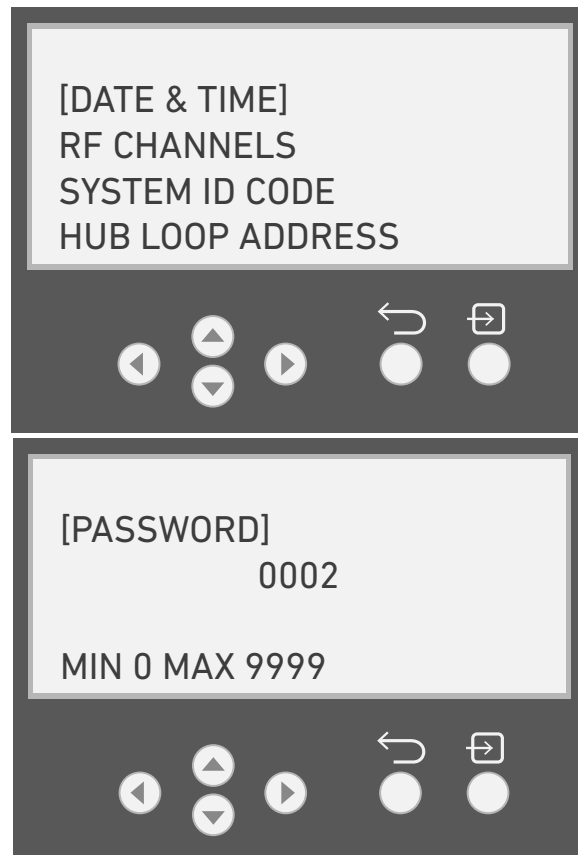

### External Jamming

If the RW1700-030APO Loop Interface is regularly attempting to communicate with paired REACH products and is unable to due to other communication on the same RF channel, it will alert the user to this problem in one of two ways:

1. **DISPLAY ONLY** will display an icon on the LCD screen
2. **GENERATE FAULT** will report a fault to the addressable fire panel via an analogue value.

By default, this will only be displayed on the LCD screen which will not be visible when installed.

### Tamper

The tamper option can be used to enable or disable the tamper fault on the **RW1700-030APO** Loop Interface.

This is not a global setting for every REACH device that is connected to the **RW1700-030APO** Loop Interface. It will only affect the Loop Interface itself.

When enabled, the **RW1700-030APO** Loop Interface will report an analogue value of 4 (see appendix 3) to the fire panel.

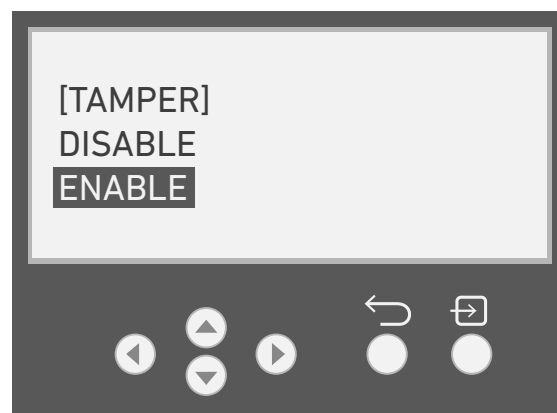



## About

The about screen displays attributes of the **RW1700-030APO** Loop Interface.

The firmware version and production lot may be requested by Apollo in the event that support is required.

Unique ID	The unique identifier of the Loop Interface
Type	Network Device
Firmware Version	1.0.4
Production Lot	Month / Year

## Tone Period (S)

The tone period setting is a value in seconds (s) that is used to 'count in' a sounder to allow it to synchronize with sounders already activated.

In order to properly sync sounders, the length (s) of the selected sounder tone must be divisible by the tone period.

*Note: As REACH Tones are selected in pairs, the length of both the primary and secondary tone must be considered.*

*Note: Longer tone periods increase delay in 'counting in' a sounder before activating.*

For sites using the same tone pair throughout, **the below table shows the optimal sync period value.**

A tone period of 4s is set by default. This can be used for all tones other than tone 7 (Swedish Fire Signal), however, many tones will have improved activation performance if a shorter 2s tone period can be used.

Tone	DIP Switch	Primary Tone Designation	Primary Tone Pattern Description	Secondary Tone Designation	Secondary Tone Pattern Description	Sync Period
1	00000	Apollo Fire Systems Evacuate Tone	660Hz for 0.5s, 925Hz for 0.5s	Apollo Fire Systems Alert Tone	1s off, 925Hz for 1s	2
2	00001	Alternaternating warble (Hochiki & Fullleon)	925Hz for 0.25s, 626Hz for 0.25s	Continuous (Hochiki & Fullleon)	925Hz	2
3	00010	Sweep (med) @ 1Hz	800Hz - 970Hz @ 1Hz	Continuous	970Hz Continuous (BS5839-1:2002)	2
4	00011	Sweep (fast) @ 9Hz	2500Hz-2850Hz @ 9Hz	Continuous	2850Hz continuous	2
5	00100	Netherlands – NEN 2575:2000 (Dutch Slow Whoop)	500 – 1200Hz for 3.5s, 0.5s OFF	Continuous	825Hz continuous	4
6	00101	German DIN 33 404	1200Hz – 500Hz Sweep 1s (1Hz)	Continuous	825Hz Continuous	2
7	00110	Swedish Fire Signal	660Hz 0.15s ON, 0.15s OFF	Swedish All Clear	660Hz Continuous	6
8	00111	Australia Fast-rise Sweep (AS1670:4-2004 Evacuation tone)	3x (500Hz - 1200Hz for 0.5s, 0.5s off), 1s off	Australia AS1670:4-2004 Alert tone	420Hz 0.625s ON, 0.625s OFF	4(2)
9	01000	New Zealand Slow-rise Sweep Evacuation Tone (NZS 4512)	500Hz – 1200Hz, 3.75s Sweep, 0.25s OFF	New Zealand Alert Tone (NZS 4512)	420Hz 0.625s ON, 0.625s OFF	4(2)
10	01001	US Temporal LF (ISO 8201) Low tone	3x(970Hz 0.5s ON, 0.5s OFF), 1s OFF	Continuous	970Hz Continuous	4
11	01010	US Temporal HF ISO 8201 High tone	3x(2850Hz 0.5s ON, 0.5s OFF), 1s off	Continuous	2850Hz continuous	4
12	01011	Simulated Bell - Continuous	827Hz for 16ms followed by 990Hz for 16ms.	Simulated Bell - Intermittent	827Hz for 16ms followed by 990Hz for 16ms for 1s then 1s off.	2
13	01100	Emergency Warning Siren	600Hz – 1200Hz 4s followed by 1200 – 600Hz 4s	Emergency Warning Siren All Clear	1200Hz Continuous	2(1)
14	01101	France – AFNOR NF S 32 001	554Hz, 0.1s, 440Hz, 0.4s	Continuous	970Hz Continuous	2
15	01110	Australia Evacuation (AS7240-3)	520Hz, 0.5s ON, 0.5s OFF x 3, 1s OFF	Australia Alert (AS7240-3)	520Hz +/-5%, 0.5s ON, 3.5s OFF	4
16	10000	Silent Tone (Reach Wireless ONLY)	0Hz Continuous	Silent Tone (Reach Wireless ONLY)	0Hz Continuous	2

## Main Menu

These screens become visible only outside of configuration mode. In this state, the REACH system is 'released' and will become visible on the analogue addressable loop using the settings defined in configuration mode.

## System Status

This menu contains options to view the current status of the REACH system. This can be used to diagnose faults.

## Device Event Log

This screen contains two options:

- View Event Log
- Clear Event Log

If **VIEW EVENT LOG** is selected, the **RW1700-030APO** Loop Interface LCD will display an event.

The screen layout shows the event date and time, followed by the event number.

It then shows the details of the device that created the event, starting with the loop address and the product type such as 'DETECTOR'.

Finally, it will show details of what the event was. For example 'TAMPER – ON'

See appendix 4 for a list of all log event types & descriptions.

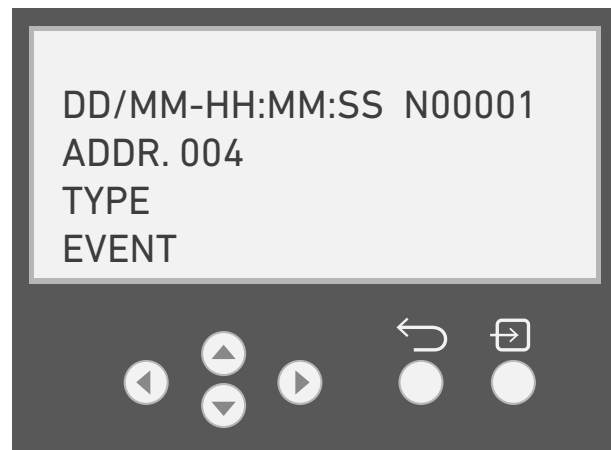

## View Device Status

This screen can be used to scroll through connected devices, according to their loop address and view their status.

The initial screen is to help identify the device you wish to view the status of. Use the arrow buttons to scroll through the loop addresses and find the product that you are looking for. The device Type and Unique ID are displayed to help with this.

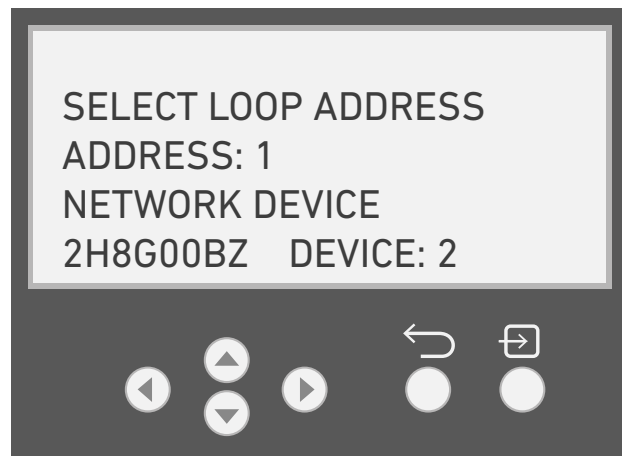

Once a product is selected, a large amount of information is available about the product itself. This can be used to identify or troubleshoot issues with the product. Apollo may ask for this information when providing support.

At the bottom of this list is the **DEVICE FLAGS** option. Select this to see the current device status.

Possible Flags Include:

- Normal operation -Normal-
- Failure/Fault -Fault-
- Sabotage/Tamper -Tamper-
- No communication with product -Link fault-
- Startup -Power on-
- -Battery low-

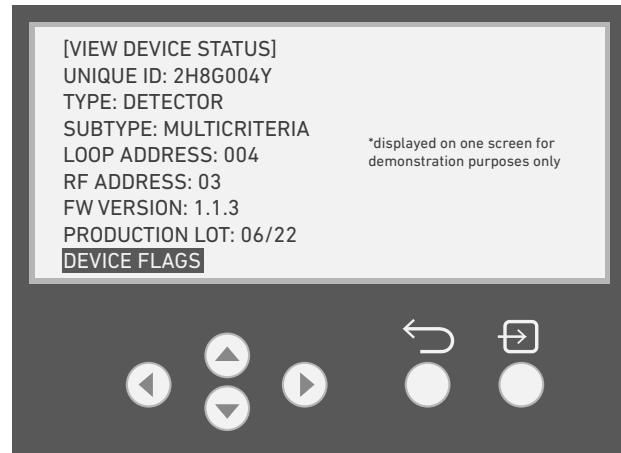

**Device Link Quality**

**ADD** = Loop Address

**HUB** = Signal strength of the last communication received by the Hub, from the device (dBm)

**DEV** = Signal strength of the last communication received by the Device, from the Hub (dBm)

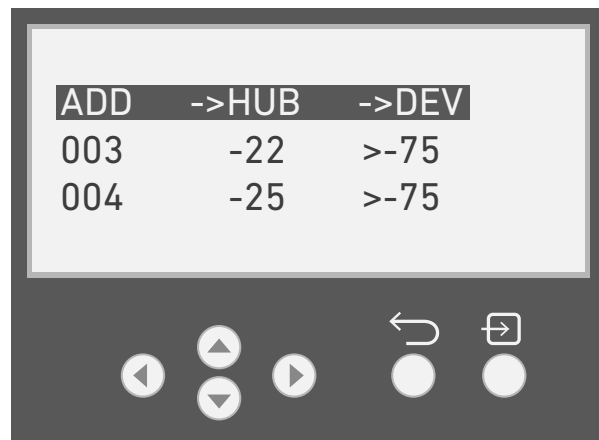

Apollo does not recommend marginal signal quality or less as an acceptable value, as this will result in variable connection strength, requiring repeated transmission and degraded battery-life.

Device Link Quality Table		
Rssi (dBm)		Signal Quality
Min.	Max	
0	-65	Excellent
-66	-75	Good
-76	-80	Sufficient
-81	-85	Marginal
-86	-90	Bad
-91	-95	Very bad
-96	-100	Extremely bad
-101	-105	Range limit

### Background Noise

This screen shows the background noise (dBm) for Channel A and Channel B or the RF Channel Pair in-use.

*A larger -dBm number indicates less background noise. Further from 0dBm is better.*

- Excellent = (-125dBm or better)
- Good = (Between -110dBm and -125dBm)
- Poor = (Between -105dBm and -110dBm)
- Very Poor = (-105dBm or worse)



If this screen is showing high levels of RF noise, RF communication with paired devices may be negatively affected and could cause repeated or delayed communication, as well as link faults. This would also negatively affect battery life as a result.

If you are experiencing issues try the following troubleshooting steps:

1. Re-check the installation section of the manual that discusses environment conditions. Has anything changed since installation?
2. Are there any other RF devices installed that could be communicating on the same RF channels?
3. Re-survey the site – does this noise show in the background scan?
  - a. Does it affect all channels?
    - i. If yes and this wasn't found during the initial survey, then it must be something in step 1 or 2.
    - ii. If this was found during the initial survey, and the root cause either could not be identified or could not be changed, then the site is not suitable for a REACH Wireless installation.
  - b. Does it only affect certain channels?
    - i. Try re-configuring the system to use these channels. This will require the REACH system to be factory reset, so this should only be done by a competent person and with access to the commissioning sheet that was filled in when the system was originally installed.

### Config. Mode

This option is used to re-enter configuration mode.

The password will need to be entered in order to access configuration mode. This may have been changed from the default during installation.

*Note: The default password is 0002.*

If you have lost or forgotten your password, please contact Apollo technical support for your device's hidden password. This is unique to your **RW1700-030APO** Loop Interface.

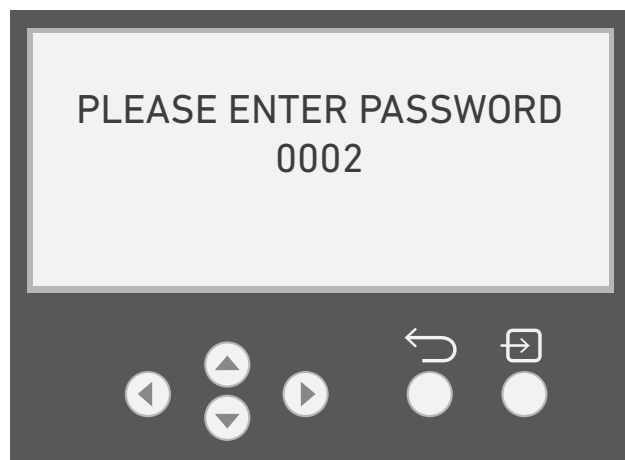

## Appendix 1: REACH / XPander RF Channel Map

When installing a REACH Wireless system within the wireless vicinity of each other, it is important to ensure that both systems are:

1. Operating on different RF Frequencies
2. Maintaining a 0.05Mhz gap between each other

*(1) should be the case for any RF wireless system install, including REACH-only or XPander-only systems. (2) is required to prevent communication issues with XPander systems and is required for XPander-only or XPander/REACH mix systems. REACH-only installations only need to be set to different channel pairs.*

The REACH/XPander RF Map document will aid in the frequency/channel selection process if a REACH or XPander wireless system is already installed in-range. To access the channel map, visit [apollo-fire.co.uk/training-support/rf-channel-map](http://apollo-fire.co.uk/training-support/rf-channel-map) or scan this QR code:



## Appendix 2: Device XP95 Device Codes

Device	Type Code	
	S90	XP
REACH Loop Interface Module	4	16
REACH Optical Smoke Detector	5	20
REACH Multisensor Smoke Detector	5	23
REACH Heat Detector	6	24
REACH Manual Call Point	7	31
REACH AV Devices	1	4
REACH Input Module	4	17
REACH Output Module	2	8
REACH Remote Indicator Module	2	8

### Appendix 3: Device Analogue Values

State	Loop Interface Module	Detectors	Manual Call Point	AV Devices	Input Module	Output Module	Remote Indicator Module
Quiescent	16	25	16	16	16	16	16
Pre-Alarm	N/A	50	N/A	N/A	N/A	N/A	N/A
Alarm	N/A	85	64	N/A	64	N/A	N/A
Self-test Passed	64	85	64	N/A	64	N/A	N/A
Self-test Failed	16	25	16	N/A	16	N/A	N/A
Drift Limit Reached	N/A	35	N/A	N/A	N/A	N/A	N/A
Power Fault	N/A	7	7	7	7	7	7
Link Fault	5	5	5	5	5	5	5
General/Tamper Fault	4	4	4	4	4	4	4
Detector/Sounder Fault	N/A	1	N/A	1	N/A	N/A	N/A



## Appendix 4: Event Log Messages

LOG Event	Value	Description	Action
Sub. Attempt	ON	Substitution attempt detected: a device communicates with the HUB using the same RF address of another device correctly paired.	Look for the device/devices that caused the substitution attempt: LEDs blink amber two times and repeat the blinking periodically. Remove batteries. Power cycle the Loop Interface. Optional: Re-pair device.
Field Ch A Jam	ON	Noise detected on RF Ch A.	Check for external RF interference.
Field Ch A Jam.	OFF	Back to normal condition.	
Field Ch B Jam.	ON	Noise detected on RF Ch B.	Check for external RF interference.
Field Ch B Jam.	OFF	Back to normal condition.	
Link Fault	ON	Device is not communicating with the HUB	Check for the device condition and position
Link Fault	OFF	Back to normal condition	
Tamper	ON	Device is not communicating with the HUB	Check for the device condition and position
Tamper	OFF	Back to normal condition	
Interface flt	ON	Isolators active	Loop connection lost/down
Interface flt	OFF	Back to normal condition	Loop connection restored
Date time edit	ON	Date or time modified	-
Batter A Low	ON	Battery A missing or low charge	Change both device batteries
Batter A Low	OFF	Back to normal condition	
Batter B Low	ON	Battery B missing or low charge	Change both device batteries
Batter B Low	OFF	Back to normal condition	
Alarm	ON	Device alarm	-
Alarm	OFF	Back to normal condition	
Fault	ON	The fault is detailed with other log events	-
Fault	OFF	Back to normal condition	
General Fault	ON	General device fault	Check the device condition
General Fault	OFF	Back to normal conditions	
Contamination	ON	Photo chamber contaminated	Check Optical Detector device photo chamber
Contamination	OFF	Back to normal condition	
In. Open	ON	Supervised module input open: EOL not found	Check for device wiring and EOL
In. Open	OFF	Back to normal condition	
In. Short	ON	Supervised module input short: wiring short	Check for device wiring and EOL
In. Short	OFF	Back to normal condition	
Out.Open	ON	Supervised module output channel open: EOL not found	Check for device wiring and EOL
Out.Open	OFF	Back to normal condition	
Out. Short	ON	Supervised module output channel short: wiring short	Check for device wiring and EOL
Out. Short	OFF	Back to normal condition	
Rel. Short	ON	Output activated	-
Rel. Short	OFF	Back to normal condition	
Event Log Cleared	ON	Event log cleared	-